

ПАСПОРТ

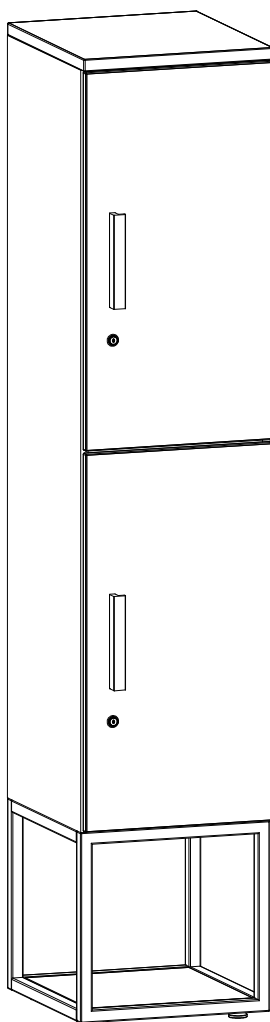



ИНСТРУКЦИЯ ПО СБОРКЕ

OASYS Локер на подставке ЛП-40х2



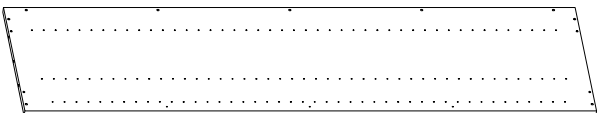
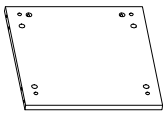
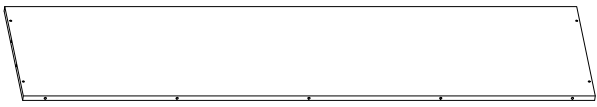

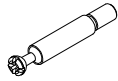
1. Комплект поставки



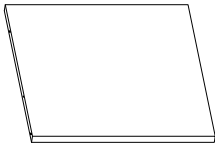

1.1. OASYS Корпус 4 ОН W40 (1 шт.)

№	Наименование	Кол-во	Изображение				
A	Боковина	2					
B	Крышка	2					
C	Задняя стенка	1					
D	Стяжка MINIFIX	12		F	Шкант 6x30	18	
E	Болт для стяжки MINIFIX	12		G	Заглушка 10	8	

1.2. OASYS Полка-разделитель W40 (1 шт.)

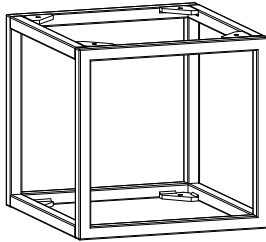
№	Наименование	Кол-во	Изображение			
H	Полка-разделитель	1				
I	Штифт 3x20	6				

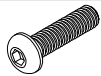
1.3. OASYS Подставка-рамка 1 ОН W40 (1 шт.)

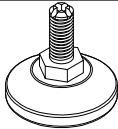
№	Наименование	Кол-во	Изображение				
J	Рама	1					
K	Вставка	2					
L	Магнит	16		N	Винт M8x30	4	
M	Саморез 3,5x13 (потайной)	16		O	Опора регулируемая M8x20	4	



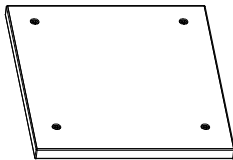
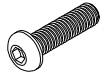

1.4. OASYS Топ W 40 (1 шт.)

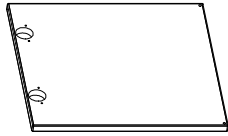
№	Наименование	Кол-во	Изображение
P	Крышка	1	
N	Винт M8x30	4	

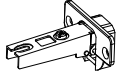

1.5. OASYS Дверь 1 ОН W40 (2 шт.)

№	Наименование	Кол-во	Изображение
Q	Дверь	1	

1.6. OASYS Комплект петель на дверь 1-3 ОН (2 шт.)

T	Планка	2		R	Демпфер	2	
				V	Демпфер силиконовый	2	
U	Петля	2		S	Саморез 4x16 (потайной)	8	

1.7. OASYS Ручка 160 (2 шт.)

№	Наименование	Кол-во	Изображение
W	Ручка 160	1	
X	Винт M4x25	2	

1.8. OASYS Замок на дверь (2 шт.)

Y	Фиксатор	1		AA	Язычок	1	
				AB	Нащельник EURO-LOCKS	1	
Z	Замок EURO-LOCKS	1		AC	Саморез 2,9x16 (потайной)	2	

2. Схема сборки

1

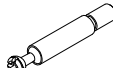
E  x 4

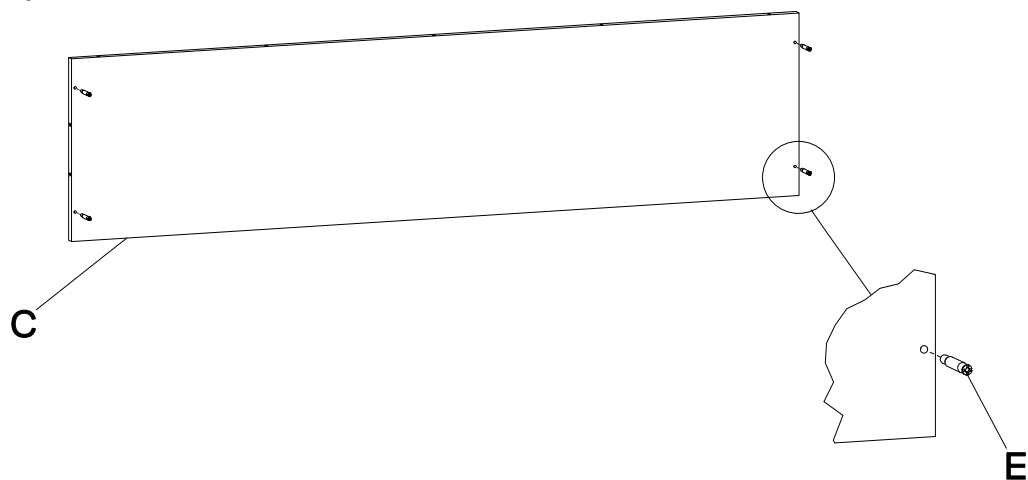

2

D  x 4

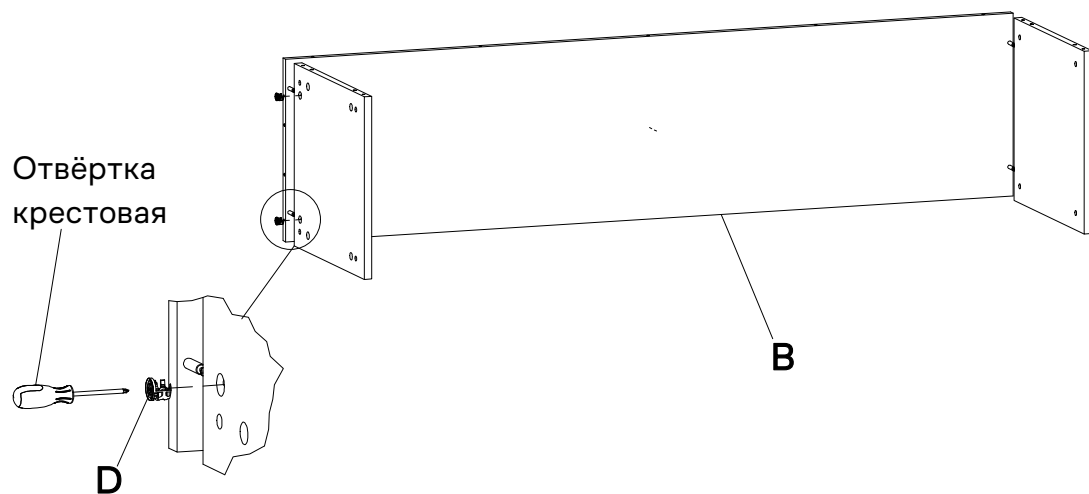

3

D  x 8

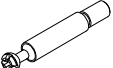
E  x 8

F  x 18

I  x 6

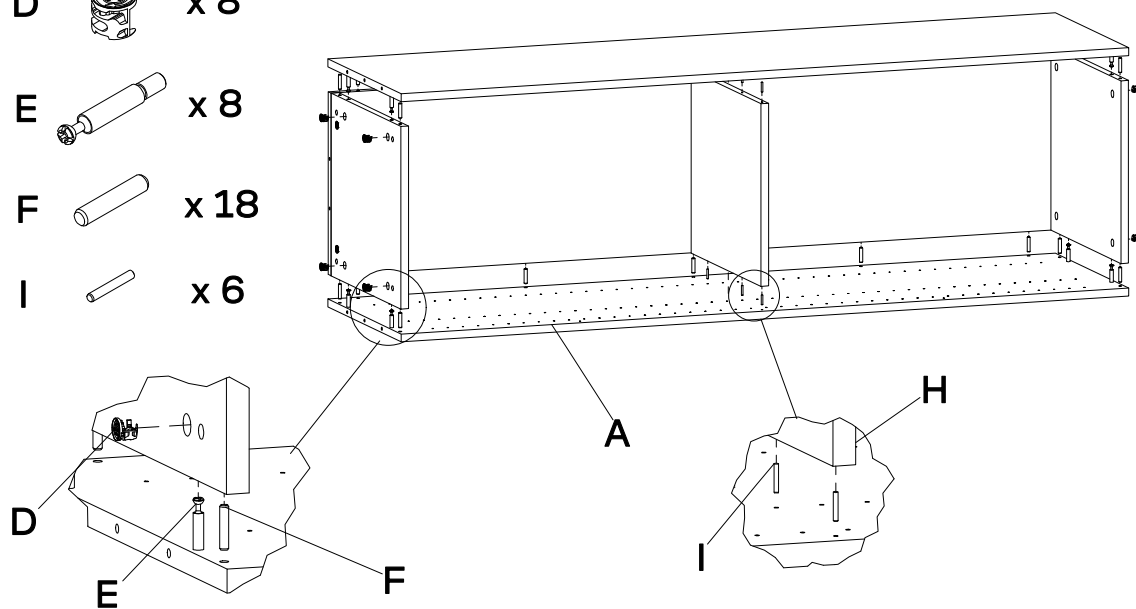

4

4

N  x 4

L  x 16

M  x 16

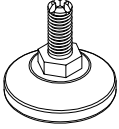
O  x 4

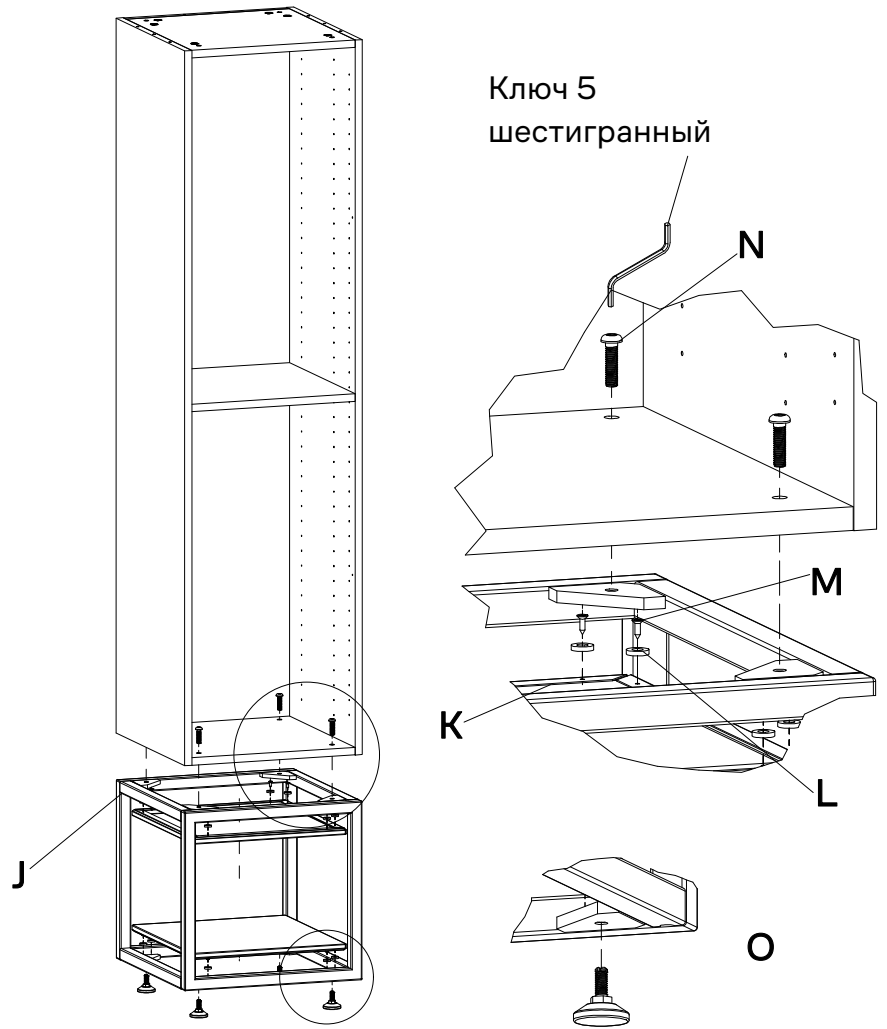

5

N  x 4

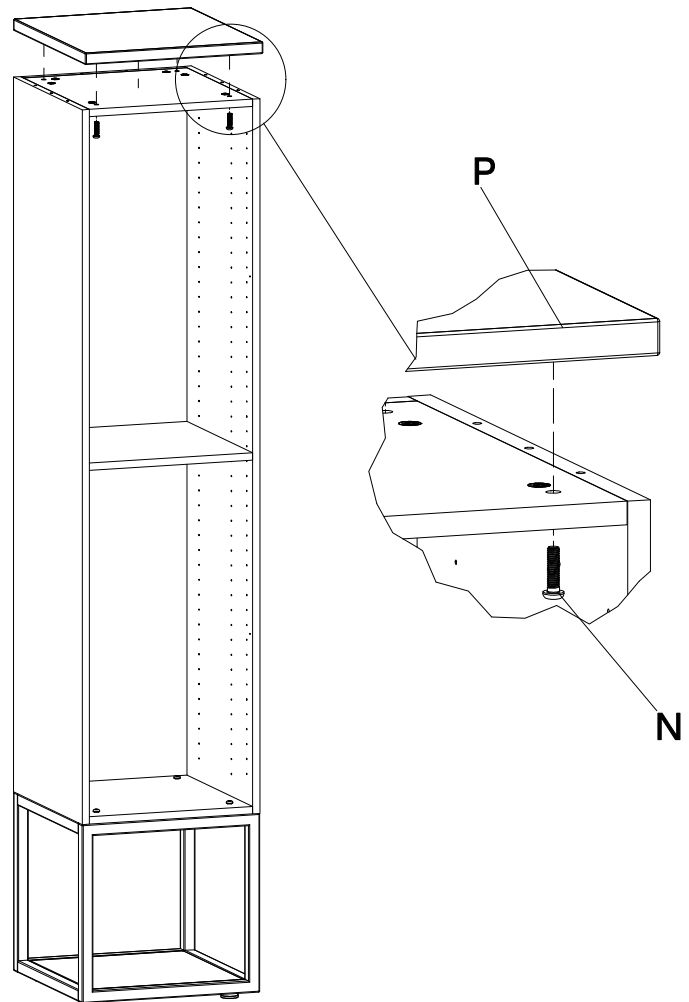

6.1

на 1 дверь:

T  x 2

S  x 4

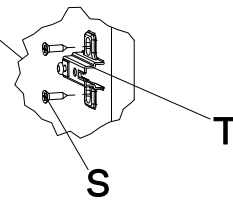
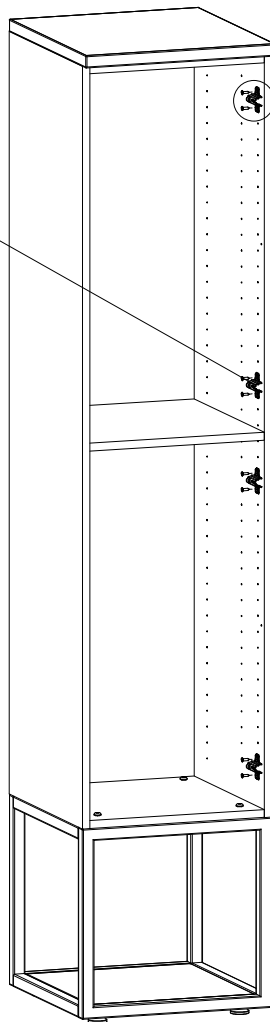

6.2

на 1 дверь:

S  x 9

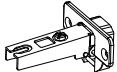
U  x 2

X  x 2

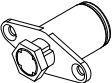
Z  x 1

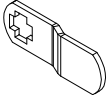
AA  x 1

AB  x 1

AC  x 2

